

### Main components

- STR730F processor running at up to 36MHz
- SPI EEPROM
- I<sup>2</sup>C EEPROM
- LCD display

### Features

- Support for the following interfaces:
  - CAN
  - RS232
- LED displays
- Buzzer
- Test buttons
- JTAG connector
- Analog channel

### Description

The STR730-EVAL board is a complete development platform for the STR73x series. The STR730-EVAL board is a cost effective, flexible and open design to demonstrate the capability of the STR730 series of flash micro-controllers and to enable rapid evaluation of the STR73x devices and available peripherals. It includes the high performance STR730F ARM7TDMI™ device that features a rich set of peripherals and serial communication interfaces, including CAN (controller area network).

The STR730-EVAL board integrates a 2 x 16 LCD, LEDs, UART, CAN interfaces, piezo buzzer and test buttons to create a versatile stand-alone test platform. A wide choice of third party development tools are readily available in addition to the those available from STMicroelectronics.

---

<b>1</b>	<b>Introduction</b>	<b>4</b>
1.1	Processor and memory devices on this board	4
1.2	Board interface connections	5
1.3	Push buttons	5
1.4	Displays	5
<b>2</b>	<b>Hardware</b>	<b>6</b>
2.1	Overview	8
2.2	Processor	8
2.3	Debug	8
2.4	Prototype area	8
2.5	Reset	8
2.6	Power supplies	8
2.7	CAN interface	8
2.8	RS232 serial interfaces	8
2.9	Analog input	9
2.10	LEDs	9
2.11	Push buttons	10
2.12	Option jumper placement	11
2.13	Option switch settings	13
<b>3</b>	<b>Connectors</b>	<b>15</b>
3.1	CAN bus connector	15
3.2	RS232 serial data connector	15
3.3	DEBUG	16
3.4	Input/output summary	17
<b>4</b>	<b>Schematics</b>	<b>21</b>
4.1	STR730-EVAL board top sheet 1 of 2	21
4.2	STR730-EVAL board top sheet 2 of 2	22
4.3	RS232 interfaces	23
4.4	SPI EEPROM interface	24
4.5	GPIO LCD	25
4.6	LED interface	26

4.7	ARM JTAG interface .....	27
4.8	CAN interface .....	28
4.9	I <sup>2</sup> C EEPROM interface .....	29
<b>5</b>	<b>Revision history .....</b>	<b>30</b>

# 1 Introduction

STMicroelectronics is a global independent semiconductor company that designs, develops, manufactures and markets a broad range of semiconductor integrated circuits and discrete devices used in a wide variety of applications.

The STR730-EVAL board is based on the STR730FZ2T7, a highly integrated microcontroller, running at up to 36 MHz that uses the popular ARM7TDMI™ 32-bit RISC CPU featuring on-chip high speed single voltage flash memory and high-speed RAM, clock generation via PLL, and numerous on-chip peripherals.

This board is intended as low cost development platform to demonstrate the capability of the STR730 series of flash micro-controllers and to enable rapid evaluation of the STR730 devices and available peripherals.

The STR730-EVAL board has 8 Kbit SPI EEPROM and 8 Kbits I<sup>2</sup>C EEPROM and supports CAN and RS232 interfaces. It includes a 2 x 16 programmable LCD display supported by select, next, back, previous and wake-up push buttons.

The hardware platform of the STR730F series is supported by an extensive software support package, including device drivers in ANSI C source form and demonstration software. It is flashed with a demonstration application that shows the basic features of the device. Development tools are readily available. This is complemented by a range of third party real-time OS and middleware.

Design schematics can also be supplied in electronic format to those customers with compatible design environments.

*Note:* ARM® and ARM7TDMI™ are registered trademarks of ARM Limited in the EU and other countries.

## 1.1 Processor and memory devices on this board

- STR730F ARM7TDMI™ processor running at up to 36 MHz, IC11:
  - 144-pin TQFP version,
  - 256 Kbytes flash program memory,
  - 16 Kbytes RAM,
  - embedded 1.8 V voltage regulator for core supply,
  - nested interrupt controller.
- Clocking is performed by a surface mounted 8 MHz quartz.
- Serial ROMs:
  - 8-kbit SPI EEPROM connected to the buffered serial peripheral interface (BSPI2): IC7,
  - I<sup>2</sup>C EEPROM: 8-kbit EEPROM connected to the I<sup>2</sup>C0 interface: IC8.

## 1.2 Board interface connections

Diagrams and wiring descriptions for these connectors are provided in [Chapter 4: Schematics on page 21](#). The following connections are supported by the board:

- CAN uses a single 9 D-type connector with microswitch selectable low or high speed transceiver: CN4
- UART0 (Rx and Tx only) connected to a 9-way male D-type RS232 connector: CN2
- UART1 (Rx and Tx only) connected to a 9-way male D-type RS232 connector: CN3
- JTAG, 20 pin IDC connector: CN1
- variable resistor, voltage range 0 to 4.5 V: R33
- LM35 temperature sensor: IC9
- prototype area: GD1
- test points, various test points are located throughout the board, for details see [Chapter 4: Schematics on page 21](#)
- main power supply: CN5

## 1.3 Push buttons

The following push buttons are provided:

- next (NEXT), programmable switch: SW12
- previous (PREV), programmable switch: SW13
- reset (RST), board reset: SW14
- select (SEL), programmable switch: SW15
- back (BACK), programmable switch: SW16
- wakeup (WAKE-UP), push button to bring processor out of low power mode: SW17

## 1.4 Displays

The following LCD and LEDs are provided:

- LCD display, 2x16 LCD display connected to a general purpose input/output LCD interface; green back light display: LCD1
- surface mount red, +5 V power indicator: LD19
- bi-color red/green: LD17, LD21, LD22, LD23, LD24, LD25
- low consumption LEDs red: LD1, LD2, LD3, LD4, LD5, LD6, LD7, LD8, LD9, LD10, LD11, LD12, LD13, LD14, LD15, LD16

## 2 Hardware

Figure 1. STR730-EVAL board layout block diagram

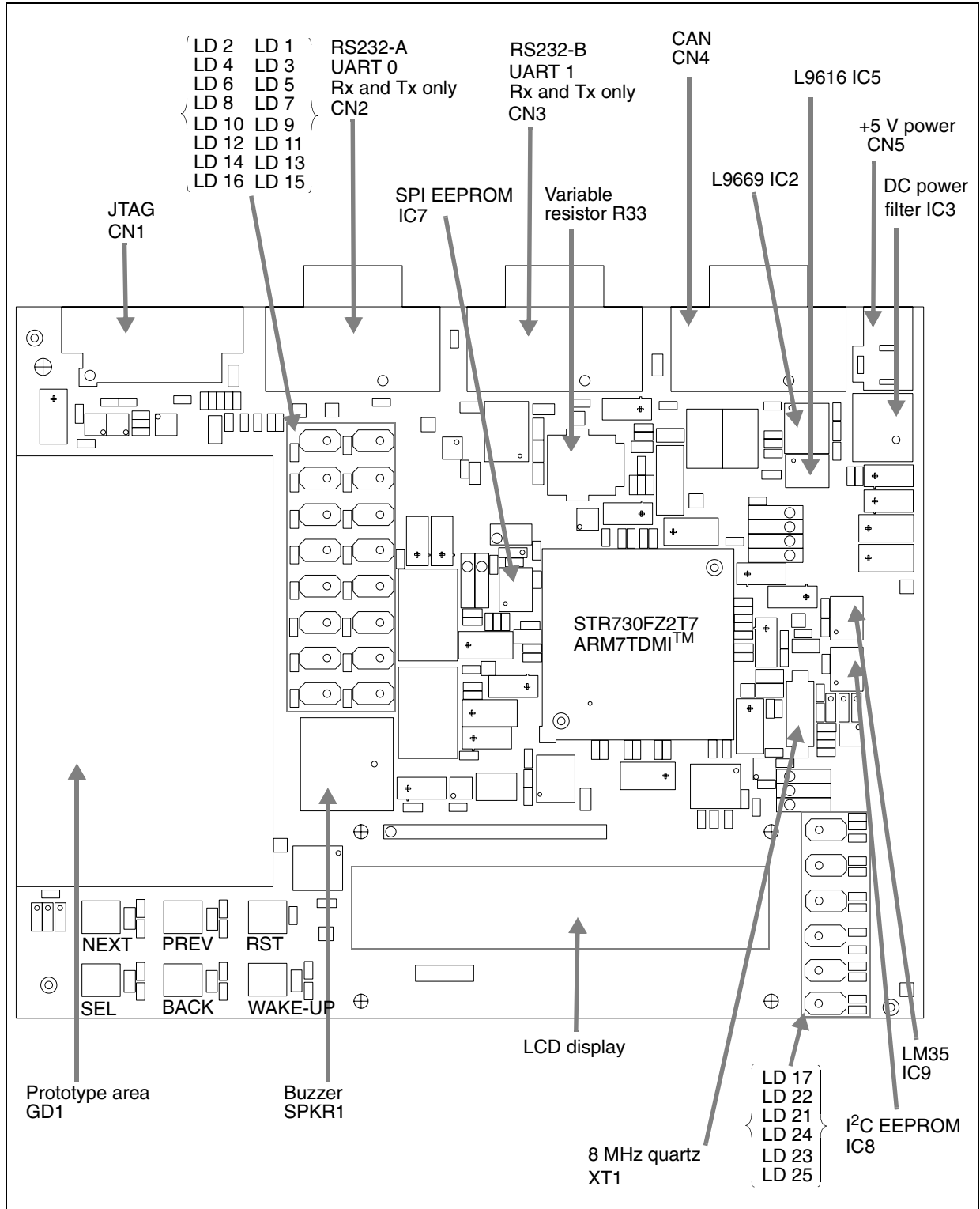
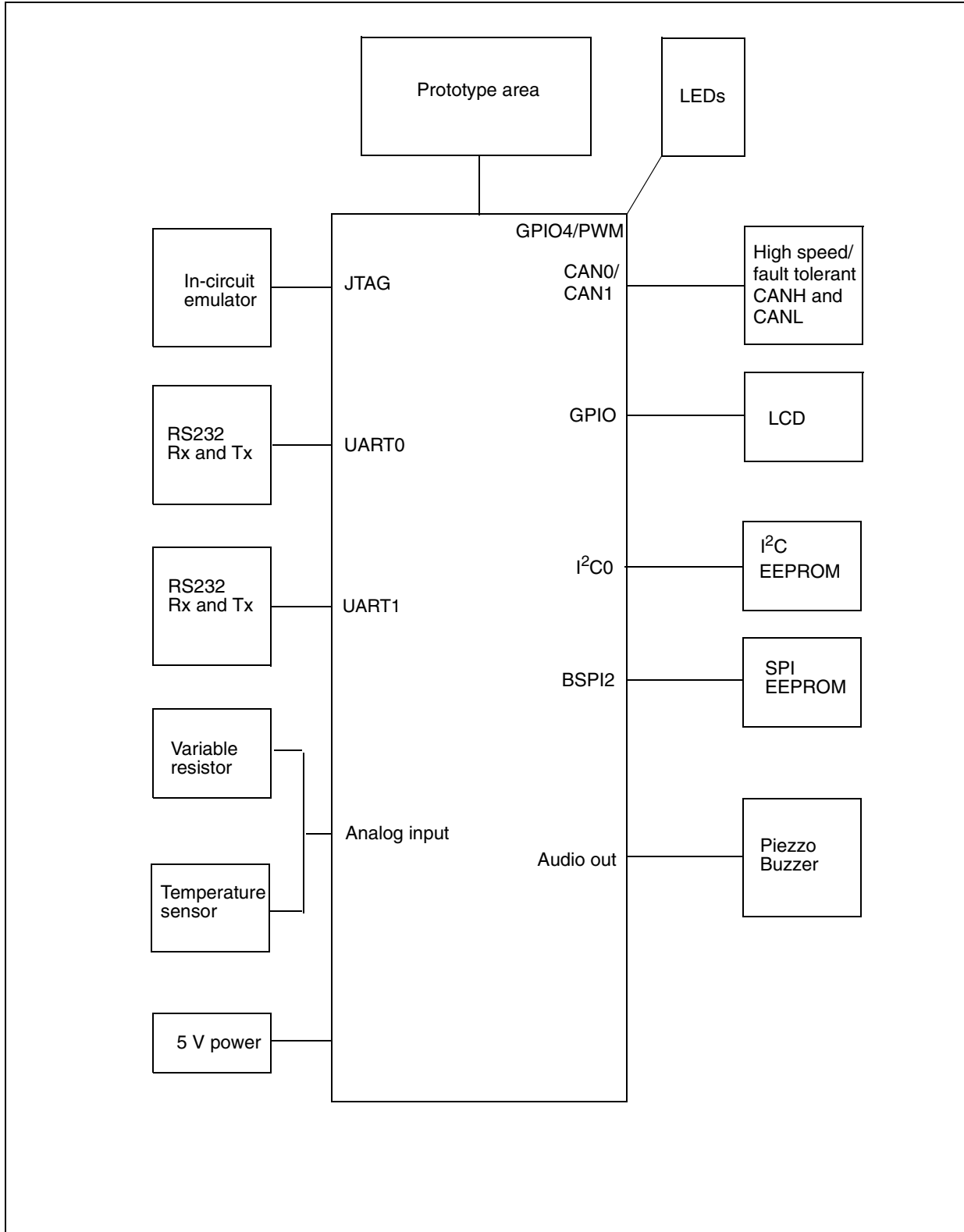

Figure 2. STR730-EVAL board system block diagram



## 2.1 Overview

The STR730-EVAL board is a general purpose evaluation platform with CAN (controller area network), and RS232 interfaces.

## 2.2 Processor

The board supports the STR730FZ2T7 ARM7TDMI-M silicon - 144-pin TQFP version. This chip runs at a frequency of up to 36 MHz.

Boot modes and configuration options are set using microswitches.

## 2.3 Debug

Software debug uses a standard 20-pin JTAG connection. This may connect to a standard host to JTAG interface.

## 2.4 Prototype area

A 2.54 x 2.54 mm gridded area of 1mm holes is available for prototyping using wire wrap or similar prototyping techniques.

## 2.5 Reset

The Reset sources are:

- power on reset,
- push button reset,
- JTAG reset from an in-circuit emulator.

## 2.6 Power supplies

Power to the board is supplied using a lump in cord power supply providing 5 V to the board. All other required voltages are provided by on-board voltage regulators.

## 2.7 CAN interface

A general purpose, asynchronous serial I/O data port connected through a 9-pin D-type male connector with microswitch selectable low speed fault tolerant transceiver (L9669) or low or high speed selectable transceiver (L9616). See [Section 3.1: CAN bus connector on page 15](#).

The L9669 transceiver only works in normal mode, the wake-up functionality is not implemented.

## 2.8 RS232 serial interfaces

Two general purpose, asynchronous serial I/O data ports are connected through 9-pin D-type male connectors refer to [Section 3.2: RS232 serial data connector on page 15](#).

RS232-A connects directly to UART0, transmit and receive only. RS232-B connects to UART1, transmit and receive only.

RTS is shorted to CTS and DTR is shorted to DSR at the connector for both interfaces.



## 2.9 Analog input

The following analog inputs are provided, see the schematics [Section 4.1 on page 21](#):

- LM35 temperature sensor IC9 is connected to AIN1,
- variable resistor R33 is connected to AIN0.

## 2.10 LEDs

### Software controlled LEDs

The LEDs in [Table 1](#) are software controlled by PIO pins.

**Table 1. Software controlled LEDs**

LED	Connected to	Color	Schematic
LD1	P4_0	Red	<a href="#">Section 4.6 on page 26</a>
LD2	P4_1		
LD3	P4_2		
LD4	P4_3		
LD5	P4_4		
LD6	P4_5		
LD7	P4_6		
LD8	P4_7		
LD9	P4_8		
LD10	P4_9		
LD11	P4_10		
LD12	P4_11		
LD13	P4_12		
LD14	P4_13		
LD15	P4_14		
LD16	P4_15		
LD17	PWM5_P2.7	Red/green	<a href="#">Section 4.1 on page 21</a>
LD21	PWM3_P2.5		
LD22	PWM4_P2.6		
LD23	PWM1_P2.3		
LD24	PWM2_P2.4		
LD25	PWM0_P2.0		

### Status LED

LD19 is the +5 V power indicator. This LED is red, see [Section 4.2 on page 22](#).

## 2.11 Push buttons

The schematic diagram for the push buttons is in [Section 4.1 on page 21](#).

**Table 2. Push buttons**

Button	Connected to:
Next SW12	INT6_P5.8
Previous SW13	INT7_P5.9
Board reset SW14	notRSTIN
Select SW15	INT8_P5.10
Back SW16	INT9_P511
Wake-up SW17	WUP16_P2.10

## 2.12 Option jumper placement

Figure 3. Option jumpers and switches

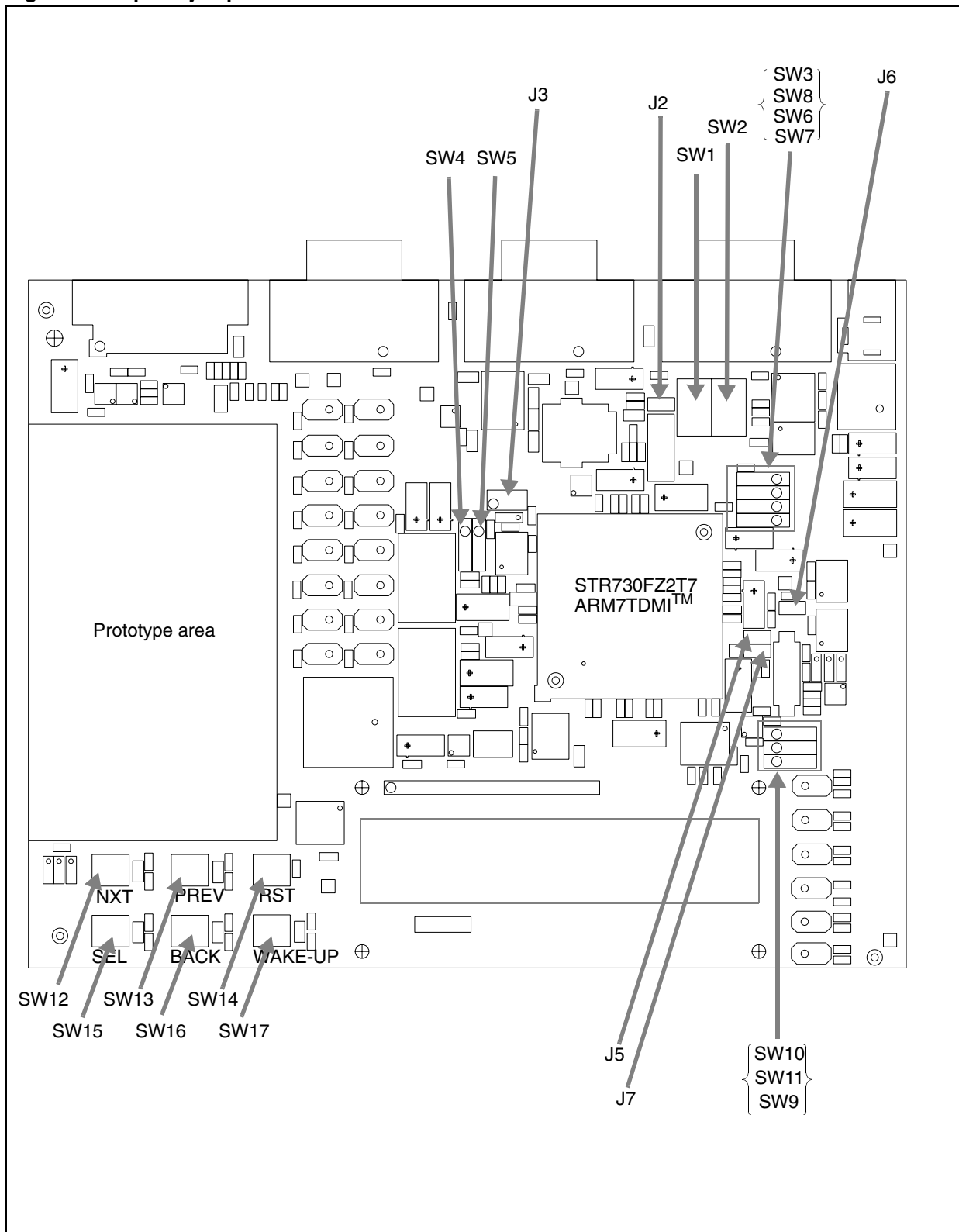

**Table 3. Option jumpers**

Jumper	Schematic	Description	Default
J2	<a href="#">Section 4.8 on page 28</a>	CAN link: not fitted / fitted (default)	Fitted
J3	<a href="#">Section 4.2 on page 22</a>	CPUIO: +5 V	Fitted
J5	<a href="#">Section 4.1 on page 21</a>	XTAL2	Fitted
J6	<a href="#">Section 4.1 on page 21</a>	TST pull-down	Fitted
J7	<a href="#">Section 4.1 on page 21</a>	XTAL1	Fitted

Jumpers are fitted as shown in [Figure 4](#):

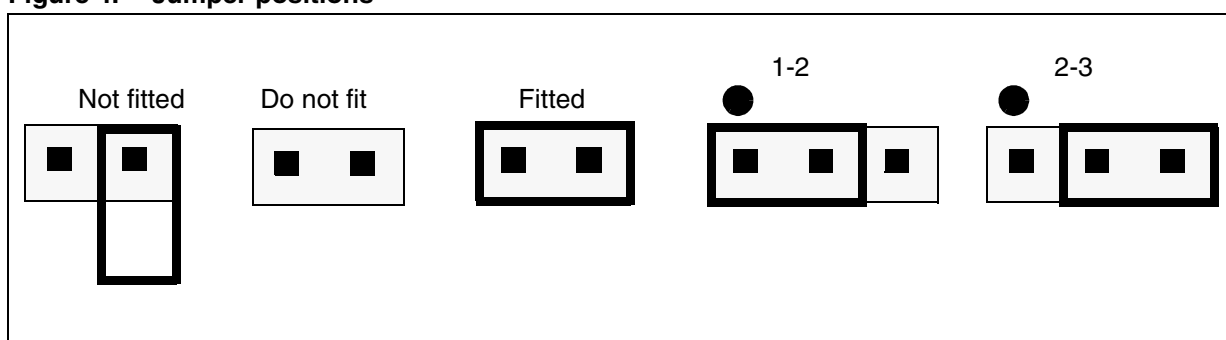
**Figure 4. Jumper positions**

## 2.13 Option switch settings

**Table 4. Option switch settings**

Switch	Schematic	Description	Default
SW1	<a href="#">Section 4.8 on page 28</a>	CAN transceiver select: L9669 / L9616 (default) Note SW1 and SW2 must be changed together. 1 = L9669 A = L9616	A
SW2			A
SW3	<a href="#">Section 4.8 on page 28</a>	L9616 ASC speed: 1-2 = pull down = high speed 2-3 = pull up = low speed	2-3
SW4	<a href="#">Section 4.4 on page 24</a>	SPI EEPROM notW: 1-2 = pull down = Write protect 2-3 = pull up = Write enabled	2-3
SW5	<a href="#">Section 4.4 on page 24</a>	SPI EEPROM notHOLD: 1-2 = pull down = SPI EEPROM in "hold mode" 2-3 = pull up = SPI EEPROM in "normal mode"	2-3
SW6	<a href="#">Section 4.1 on page 21</a>	CAN device select: channel 0 / channel 1 Note SW6 and SW8 must be changed together. 1-2 = channel 0 2-3 = channel 1	1-2
SW7	<a href="#">Section 4.9 on page 29</a>	I <sup>2</sup> C EEPROM write control (notWC): 1-2 = pull down = enable writes to EEPROM 2-3 = pull up = disable writes to EEPROM	1-2
SW8	<a href="#">Section 4.1 on page 21</a>	CAN device select: channel 0 / channel 1 Note SW6 and SW8 must be changed together. 1-2 = channel 0 2-3 = channel 1	1-2
SW9	<a href="#">Section 4.1 on page 21</a>	Bit Boot M0, boot from internal flash, see <a href="#">Table 5</a> . 1-2 = M0 low 2-3 = M0 high	1-2
SW10	<a href="#">Section 4.1 on page 21</a>	SPEAKER Channel OCPMA0 / OCPMA1 (default)	1-2
SW11	<a href="#">Section 4.1 on page 21</a>	Bit Boot M1, boot from internal flash, see <a href="#">Table 5</a> . 1-2 = M1 low 2-3 = M1 high	1-2
SW12	<a href="#">Section 4.1 on page 21</a>	Next	Push to make
SW13	<a href="#">Section 4.1 on page 21</a>	Previous	Push to make
SW14	<a href="#">Section 4.1 on page 21</a>	Reset	Push to make
SW15	<a href="#">Section 4.1 on page 21</a>	Select	Push to make
SW 16	<a href="#">Section 4.1 on page 21</a>	Back	Push to make
SW 17	<a href="#">Section 4.1 on page 21</a>	Wake up	Push to make





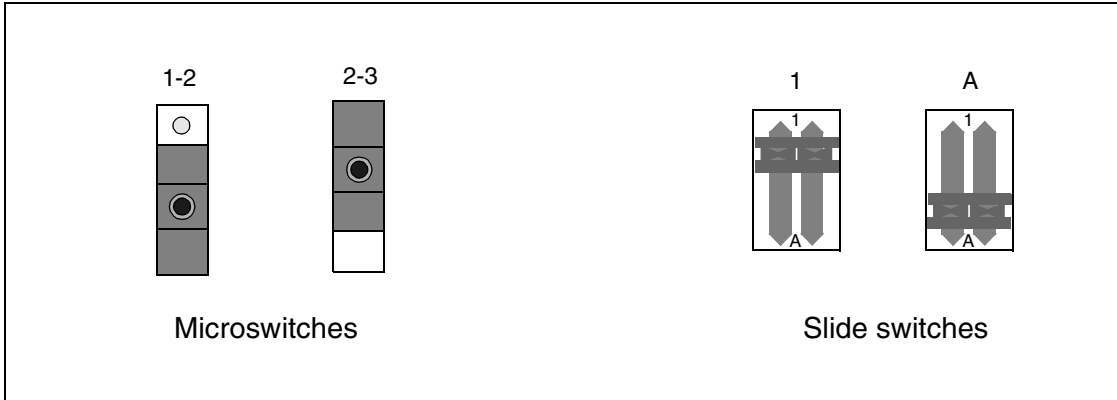





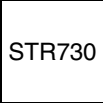



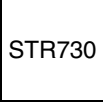

For switch position details, see [Figure 5](#).

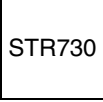
**Figure 5. Switch positions**

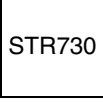

[Table 5](#) lists the boot modes.

**Table 5. Boot modes**

BootM1 SW11	BootM0 SW9	Mode	Memory mapping	Note	
1-2	1-2	User1	Flash sector B0F0 mapped at 0h.	All flash sectors visible except system memory sector.	 SW10  SW10 BOOT M1  SW11 BOOT M0  SW9
1-2	2-3	User2	Flash sector B0F0 mapped at 0h.	Flash B0F1 sector and system memory sector not visible.	 SW10  SW10 BOOT M1  SW11 BOOT M0  SW9
2-3	1-2	Boot	System memory mapped at 0h.	-	 SW10  SW10 BOOT M1  SW11 BOOT M0  SW9
2-3	2-3	Reserved	-	-	 SW10  SW10 BOOT M1  SW11 BOOT M0  SW9

### 3 Connectors

#### 3.1 CAN bus connector

Figure 6. CAN connector 9 pin male D-type: CN4

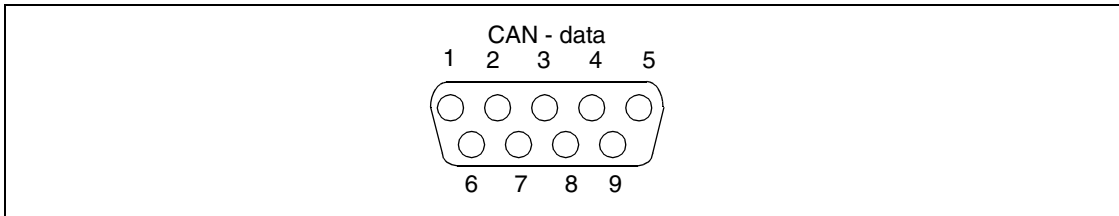

Table 6. CAN connector pinout: CN4

Pin	Description	Pin	Description	Pin	Description
1	Not connected	4	Not connected	7	CAN H, high side bus output
2	CAN L, low side bus output	5	Not connected	8	Pull down to GROUND
3	GROUND	6	GROUND	9	Pull up to +5 V

#### 3.2 RS232 serial data connector

9-pin general purpose D-type male connectors

Figure 7. RS232 transmit and receive connectors: CN2, CN3

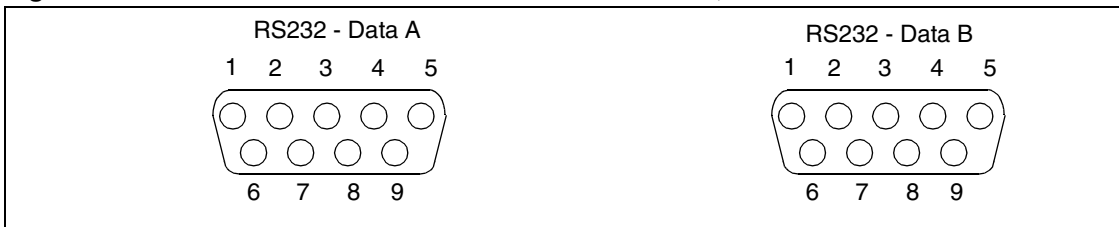
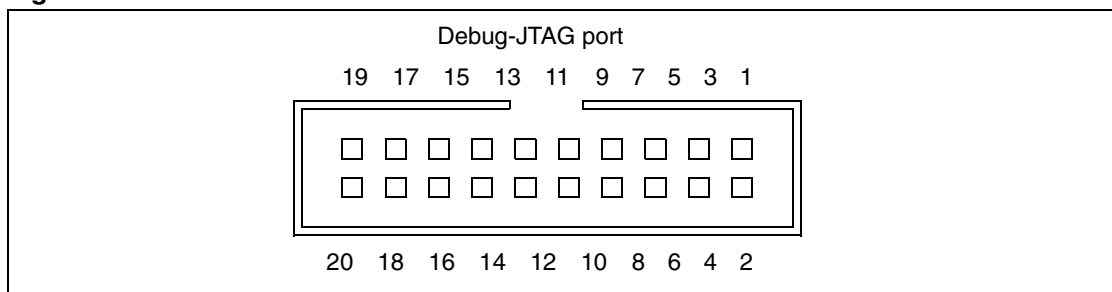

Table 7. RS232 connector pinout: CN2, CN3

Pin	Description	Pin	Description	Pin	Description
1	Shorted to pin 4 and 6	4	Shorted to pin 1 and 6	7	Shorted to pin 8
2	R1IN (port A), R2IN (port B)	5	GROUND	8	Shorted to pin 7
3	T1OUT (port A), T2OUT (port B)	6	Shorted to pin 1 and 4	9	Not connected

### 3.3 DEBUG

**Figure 8. JTAG standard interface: CN1**



**Table 8. JTAG interface pinout: CN1**

Pin	Description	Pin	Description	Pin	Description
4, 6, 8, 10, 12, 14, 16, 18, 20	GROUND	5	TDI	13	TD0
1	VTref +5 V	7	TMS	15	notReset
2	Vsupply +5 V	9	TCK	17	DBGCRQS - pulled low
3	notTRST	11	RTCK (GROUND)	19	DBGACK - pulled low

*Note:* In order for hardware and JTAG RESET to be synchronized, (R3, R6, R5, C2, TR2, TR1) have to be fitted, see [Section 4.7: ARM JTAG interface on page 27](#).



### 3.4 Input/output summary

Table 9. STR730-EVAL board input/output summary

Port	Peripheral	Alternate function	Interrupt
P0.0	LCD_D0	OCMPB2	
P0.1	LCD_D1	OCMPA2	
P0.2	LCD_D2	ICAPA2	
P0.3	LCD_D3	ICAPB2	
P0.4	LCD_D4	OCMPA5	
P0.5	LCD_D5	OCMPB5	
P0.6	LCD_D6	ICAPA5	
P0.7	LCD_D7	ICAPB5	
P0.8	LCD_RS	OCMPA6	
P0.9	LCD_nE	OCMPB6	
P0.10	LCD_RW	OCMPA7	
P0.11	TP52	OCMPB7	
P0.12	TP53	ICAPA3	
P0.13	TP54	ICAPB3	
P0.14	TP55	OCMPB3	
P0.15	TP56	OCMPA3	
P1.0	TP57	OCMPA4	
P1.1	Test Point	OCMPB4	
P1.2	Test Point	ICAPB4	
P1.3	Test Point	ICAPA4	
P1.4	Test Point		
P1.5	Test Point		
P1.6	Test Point	OCMPB1	
P1.7	PIEZO (SW10-1)	OCMPA1	
P1.8	PIEZO (SW10-3)	OCMPA0	INT0
P1.9	Test Point	OCMPB0	INT1
P1.10	Test Point		WUP28
P1.11	Test Point		WUP29
P1.12	Test Point		WUP30
P1.13	Test Point		WUP31
P1.14	CAN_RX (SW6-1)	CAN0RX	WUP12
P1.15	CAN_TX (SW8-1)	CAN0TX	

**Table 9. STR730-EVAL board input/output summary**

Port	Peripheral	Alternate function	Interrupt
P2.0	BiColor LED - LD25	PWM0	
P2.1	CAN_RX (SW6-3)	CAN1RX	WUP13
P2.2	CAN_TX (SW8-3)	CAN1TX	
P2.3	BiColor LED - LD23	PWM1	
P2.4	BiColor LED - LD24	PWM2	
P2.5	BiColor LED - LD21	PWM3	
P2.6	BiColor LED - LD22	PWM4	
P2.7	BiColor LED - LD17	PWM5	
P2.8	UART_TXB	UART1_TX	
P2.9	UART_RXB	UART1_RX	WUP14
P2.10	SW_WAKEUP		WUP16
P2.11	Test Point		WUP17
P2.12	I2C_E1 / TP		INT14
P2.13	I2C_E2 / TP		INT15
P2.14	I2C_SCL	SCL0	
P2.15	I2C_SDA	SDA0	
P3.0	10K_POT	AIN0	
P3.1	LM35_THERM	AIN1	
P3.2	Test Point	AIN2	
P3.3	Test Point	AIN3	
P3.4	Test Point	AIN4	
P3.5	Test Point	AIN5	
P3.6	Test Point	AIN6	
P3.7	Test Point	AIN7	
P3.8	Test Point	AIN8	
P3.9	Test Point	AIN9	
P3.10	Test Point	AIN10	
P3.11	Test Point	AIN11	
P3.12	Test Point	AIN12	INT2
P3.13	Test Point	AIN13	INT3
P3.14	Test Point	AIN14	INT4
P3.15	Test Point	AIN15	INT5

Table 9. STR730-EVAL board input/output summary

Port	Peripheral	Alternate function	Interrupt
P4.0	LED_LD1	ICAPA7	
P4.1	LED_LD2	ICAPB7	
P4.2	LED_LD3	ICAPA8	
P4.3	LED_LD4	ICAPB8	
P4.4	LED_LD5		
P4.5	LED_LD6		WUP18
P4.6	LED_LD7	SCL1	WUP19
P4.7	LED_LD8	SDA1	
P4.8	LED_LD9	OCMPA8	
P4.9	LED_LD10	ICAPB6	
P4.10	LED_LD11	ICAPA6	WUP20
P4.11	LED_LD12	OCMPB8	
P4.12	LED_LD13	ICAPA9	WUP21
P4.13	LED_LD14	ICAPB9	
P4.14	LED_LD15	nSS1	
P4.15	LED_LD16	SCLK1	WUP22
P5.0	TP7	MOSI1	
P5.1	TP6	MISO1	
P5.2	TP5	OCMPA9	
P5.3	M95_EE_CS	OCMPB9	
P5.4	CPU_IO	nSS2	
P5.5	M95_EE_CLK	SCLK2	WUP23
P5.6	M95_EE_MOSI	MOSI2	
P5.7	M95_EE_MISO	MISO2	
P5.8	SW_NEXT		INT6
P5.9	SW_PREV		INT7
P5.10	SW_SEL		INT8
P5.11	SW_BACK		INT9
P5.12	TP4		INT10
P5.13	TP3		INT11
P5.14	TP10		INT12
P5.15	TP14		INT13

**Table 9. STR730-EVAL board input/output summary**

Port	Peripheral	Alternate function	Interrupt
P6.0	TP13		WUP0
P6.1	TP12		WUP1
P6.2	TP11		WUP2
P6.3	TP20		WUP3
P6.4	TP17		WUP4
P6.5	TP18		WUP5
P6.6	TP22		WUP6
P6.7	TP21		WUP7
P6.8	UART_RXA	UART0_RX	WUP10
P6.9	UART_TXA	UART0_TX	
P6.10	TP19		
P6.11	TP36	MISO0	
P6.12	TP34	MOSI0	
P6.13	TP38	SCLK0	WUP11
P6.14	TP37	nSS0	
P6.15	TP35		WUP9

# 4 Schematics

## 4.1 STR730-EVAL board top sheet 1 of 2

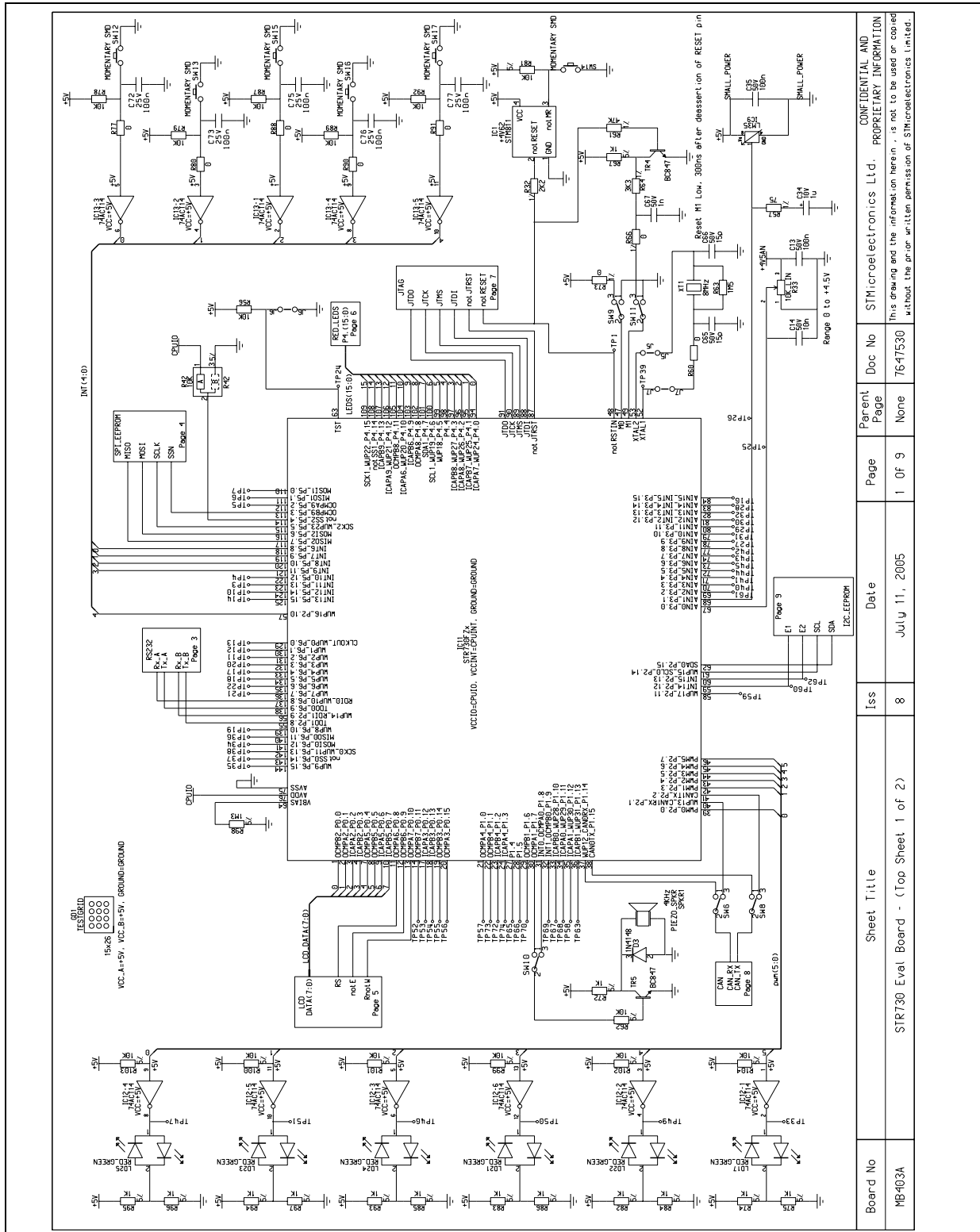

Board No	Sheet Title	Iss	Date	Page	Parent Page	Doc No	CONFIDENTIAL AND PROPRIETARY INFORMATION
MB403A	STR730 Eval Board - (Top Sheet 1 of 2)	8	July 11, 2005	1 of 9	None	7647530	This drawing and the information herein is not to be used or copied without the prior written permission of STMicroelectronics Limited.



4.2 STR730-EVAL board top sheet 2 of 2

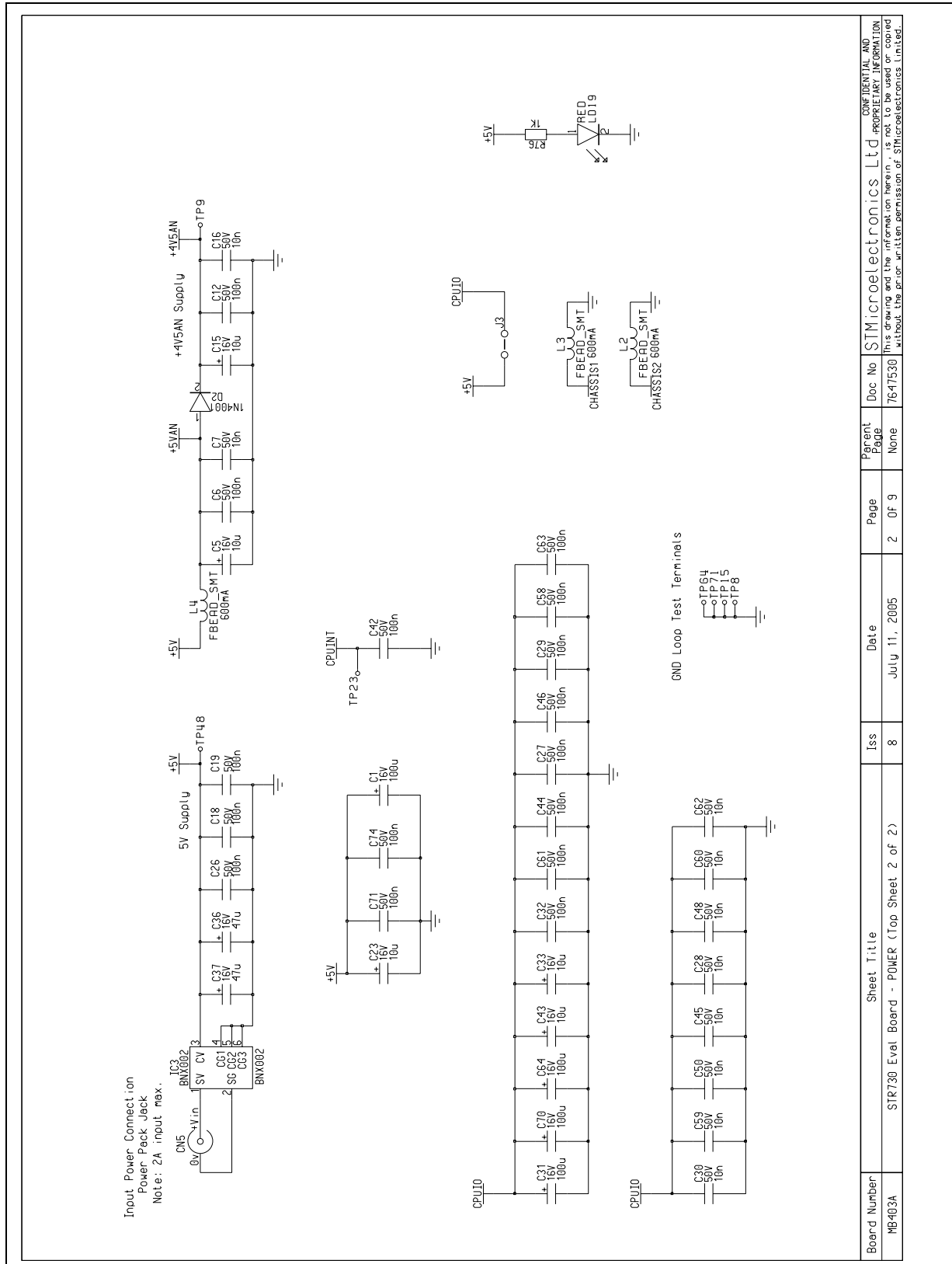

### 4.3 RS232 interfaces

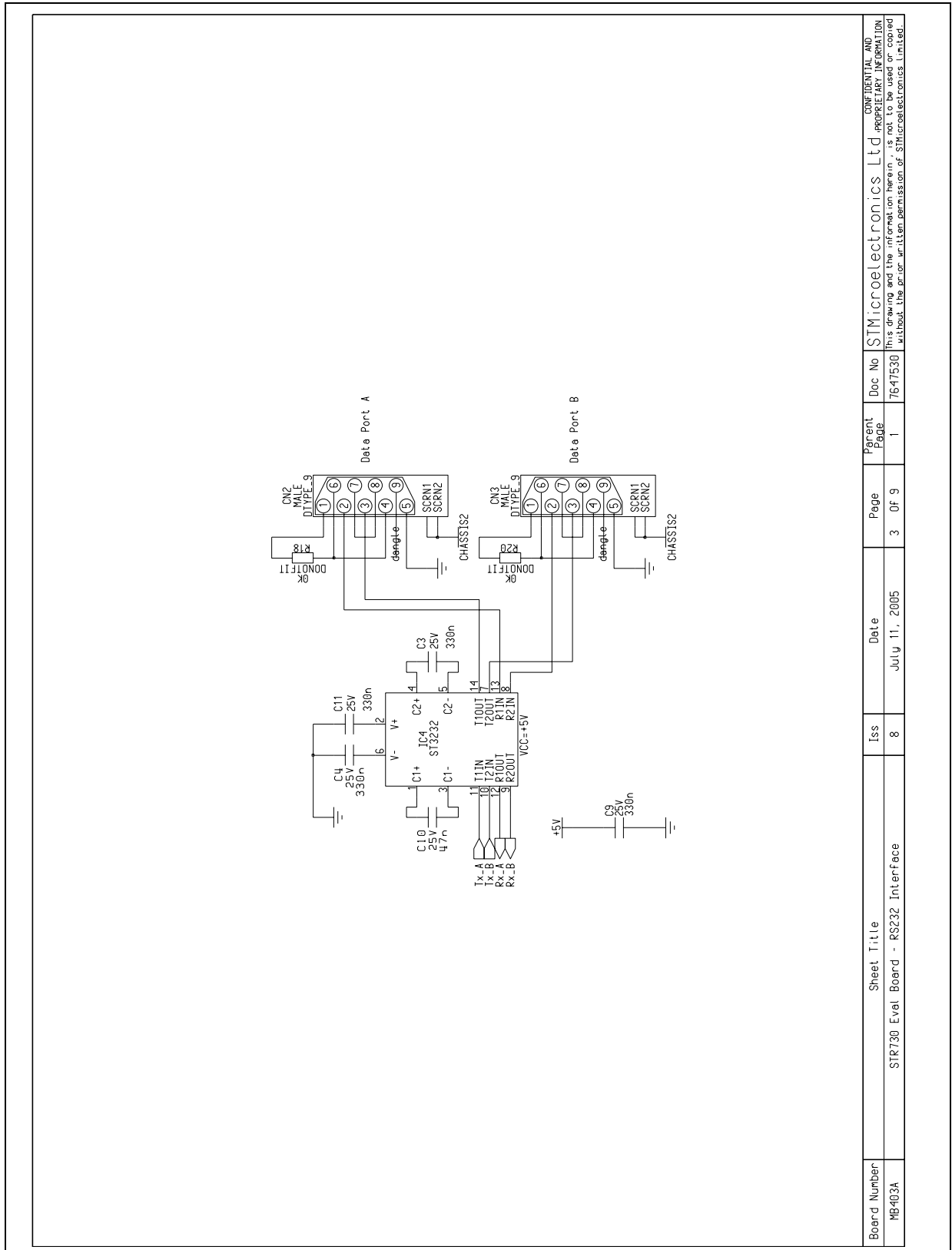

### 4.4 SPI EEPROM interface

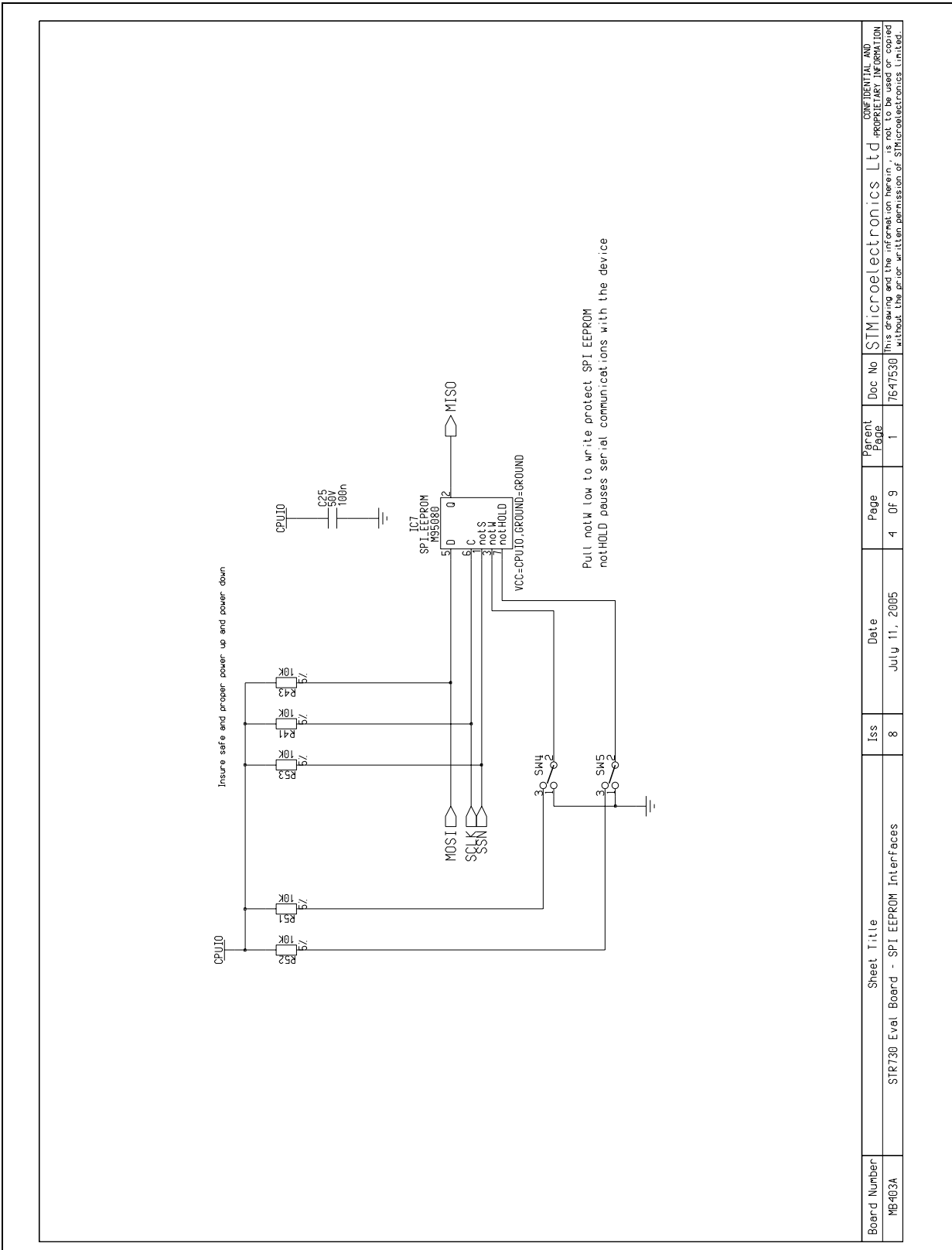

Board Number NB403A	Sheet Title STR730 Eval Board - SPI EEPROM Interfaces	Iss 8	Date July 11, 2005	Page 4 Of 9	Parent Page 1	Doc No 76-47530	STMicroelectronics Ltd CONFIDENTIAL AND PROPRIETARY INFORMATION This drawing and the information herein, is not to be used or copied without the prior written permission of STMicroelectronics Limited.
------------------------	--	----------	-----------------------	----------------	------------------	--------------------	--





# 4.5 GPIO LCD

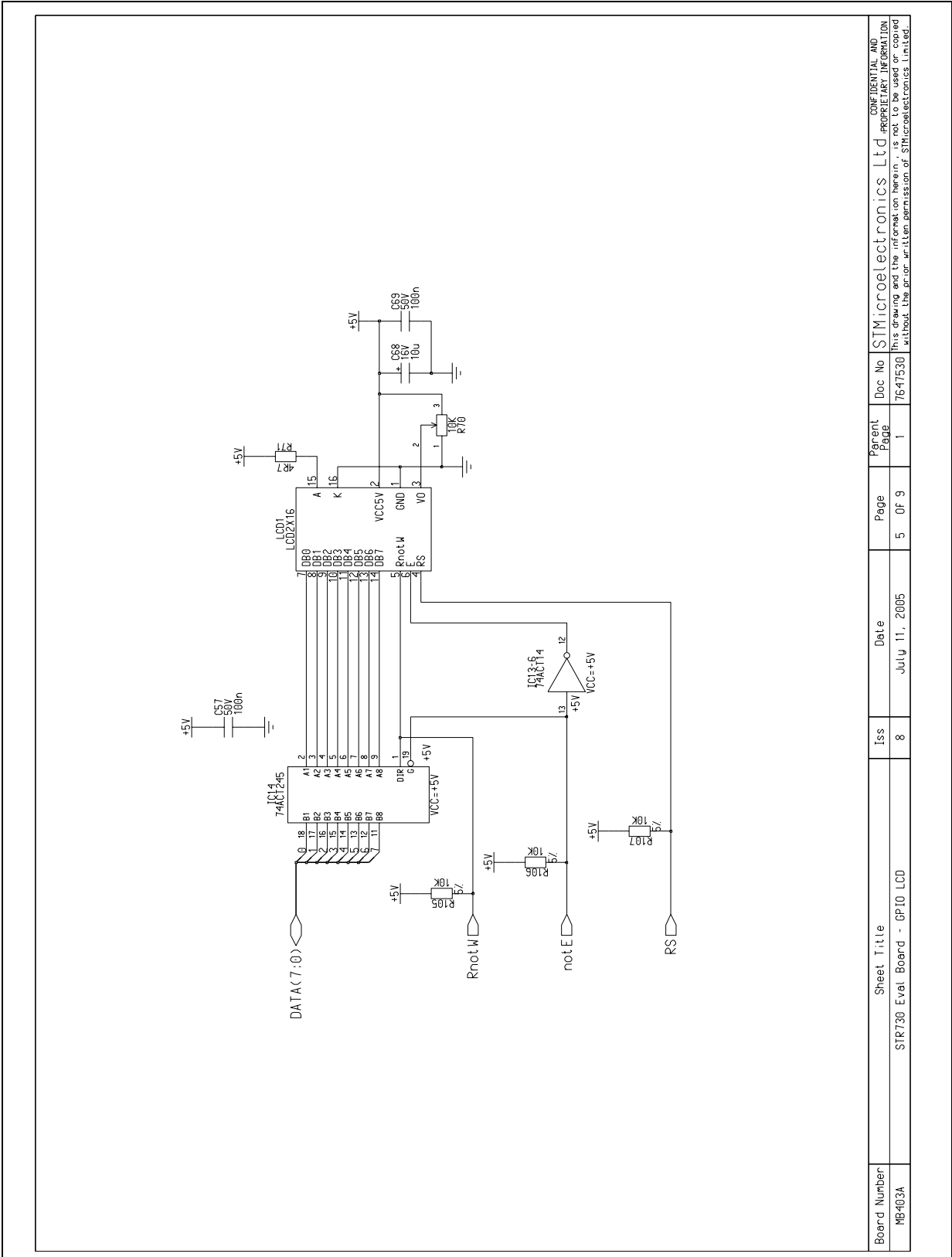

Board Number	Sheet Title	Iss	Date	Page	Parent Page	Doc No	STMicroelectronics Ltd	CONFIDENTIAL AND PROPRIETARY INFORMATION
MB403A	STR730 Eval Board - GPIO LCD	8	July 11, 2005	5 OF 9	1	7647530	STMicroelectronics Ltd	This drawing and the information herein is not to be used or copied without the prior written permission of STMicroelectronics Limited.



### 4.6 LED interface

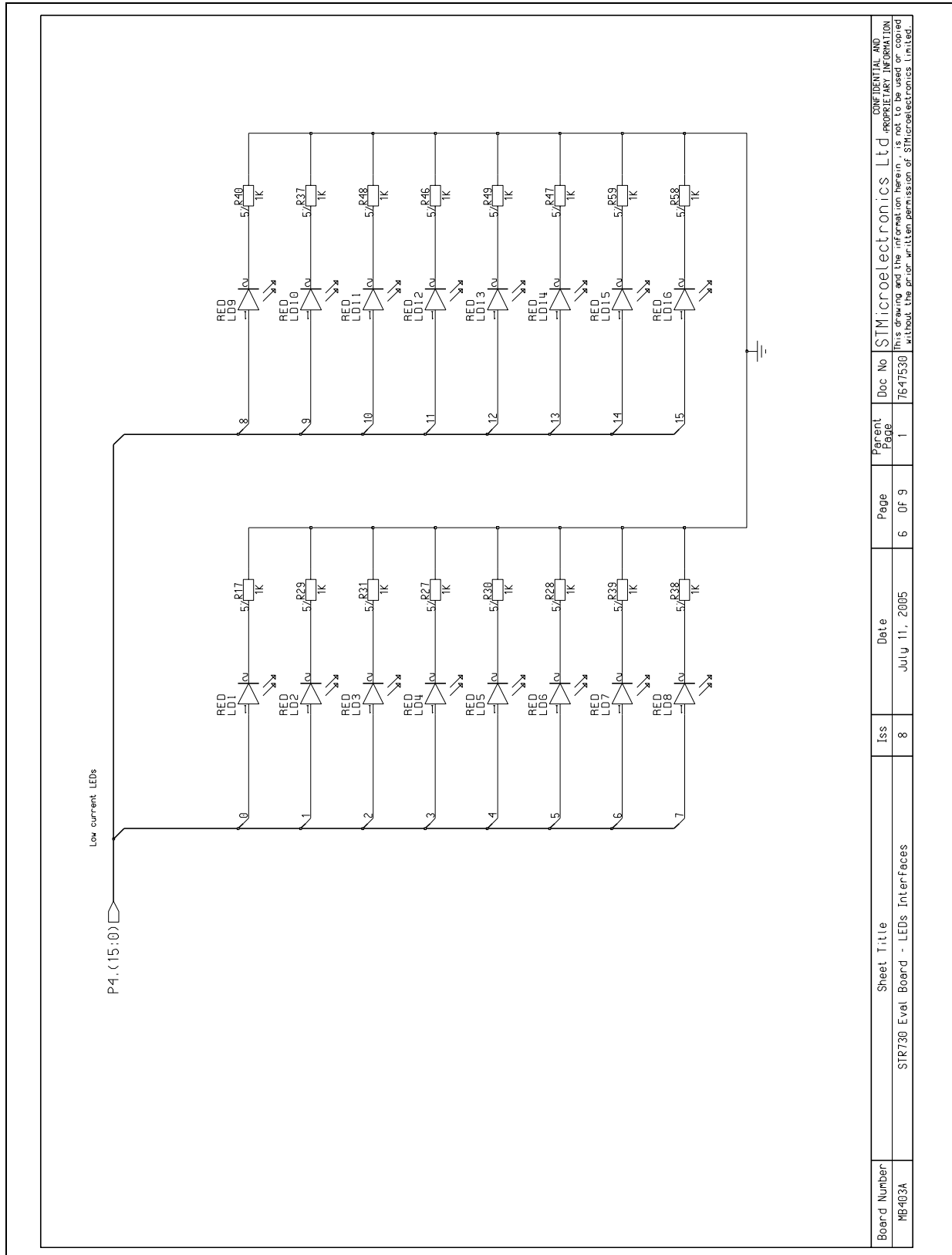

Board Number	MB403A	Sheet Title	STR730 Eval Board - LEDs Interfaces	Iss	8	Date	July 11, 2005	Page	6 Of 9	Parent Page	1	Doc No	7647530	STMicroelectronics Ltd
<small>CONFIDENTIAL AND PROPRIETARY INFORMATION                  This drawing and the information herein is not to be used or copied without the prior written permission of STMicroelectronics Limited.</small>														



### 4.7 ARM JTAG interface

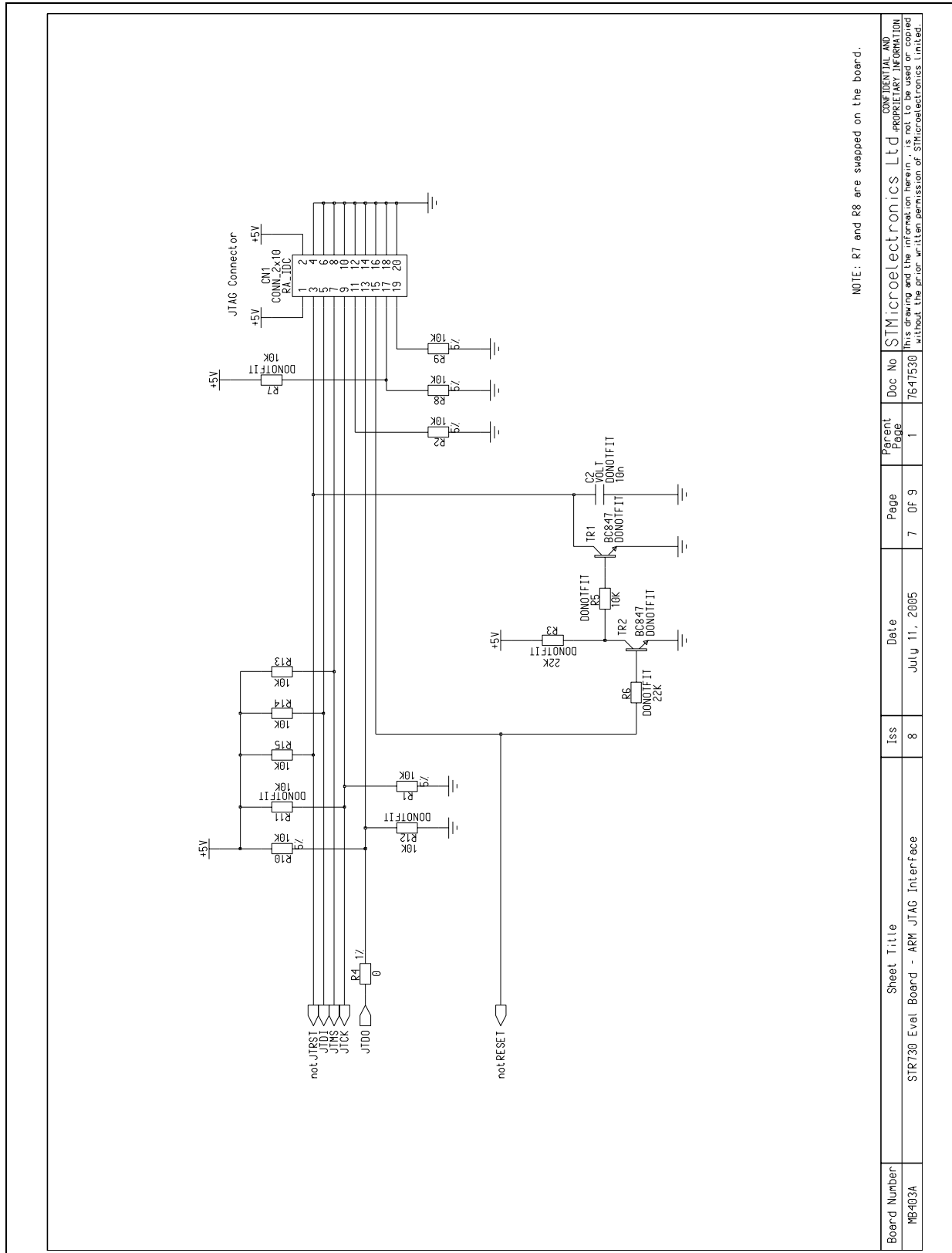

Board Number	MB403A	Sheet Title	STR730 Eval Board - ARM JTAG Interface	Iss	8	Date	July 11, 2005	Page	7 Of 9	Parent Page	1	Doc No	7647530	Doc No	7647530	Doc No	7647530	Doc No	7647530
--------------	--------	-------------	--	-----	---	------	---------------	------	--------	-------------	---	--------	---------	--------	---------	--------	---------	--------	---------



### 4.8 CAN interface

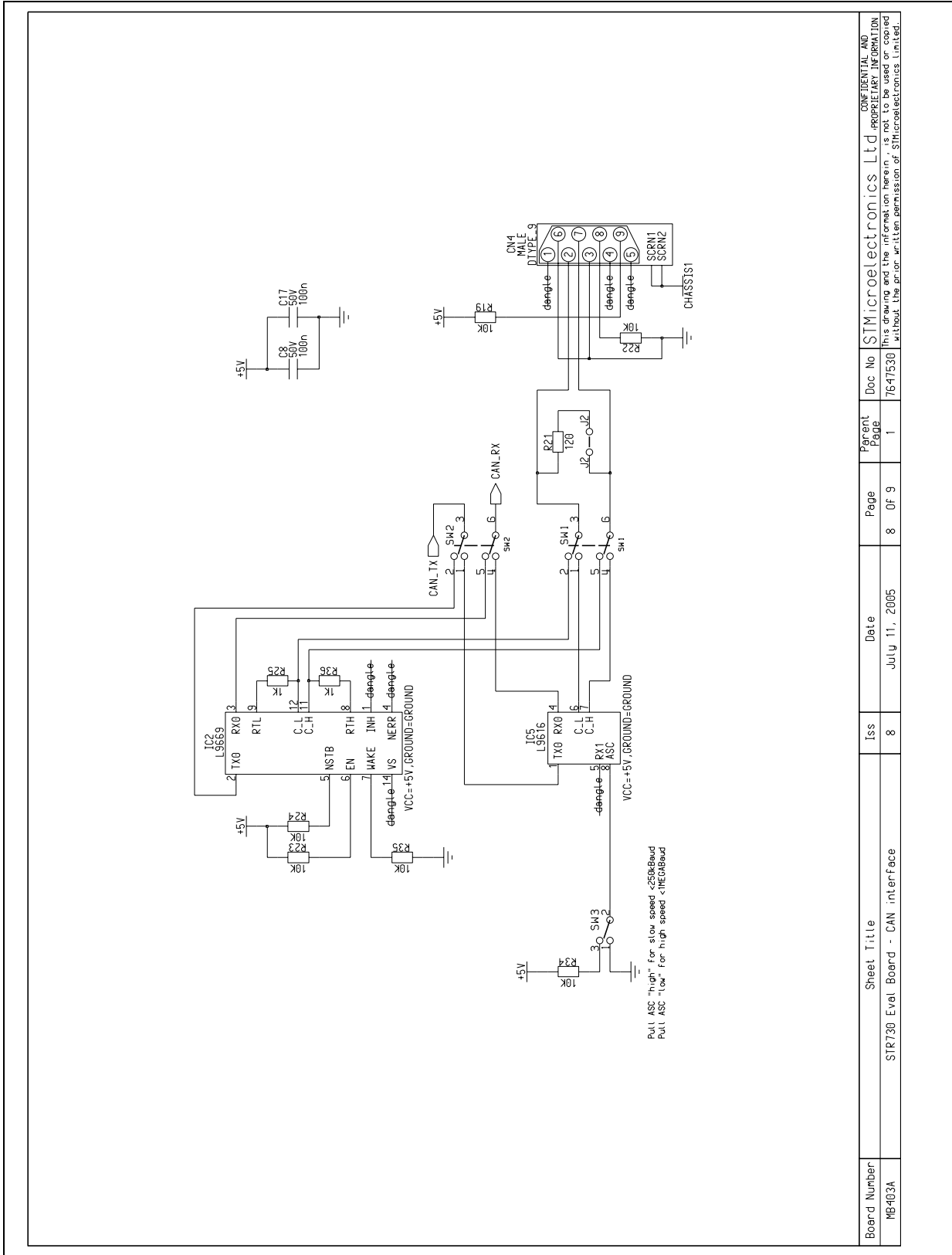

### 4.9 I<sup>2</sup>C EEPROM interface

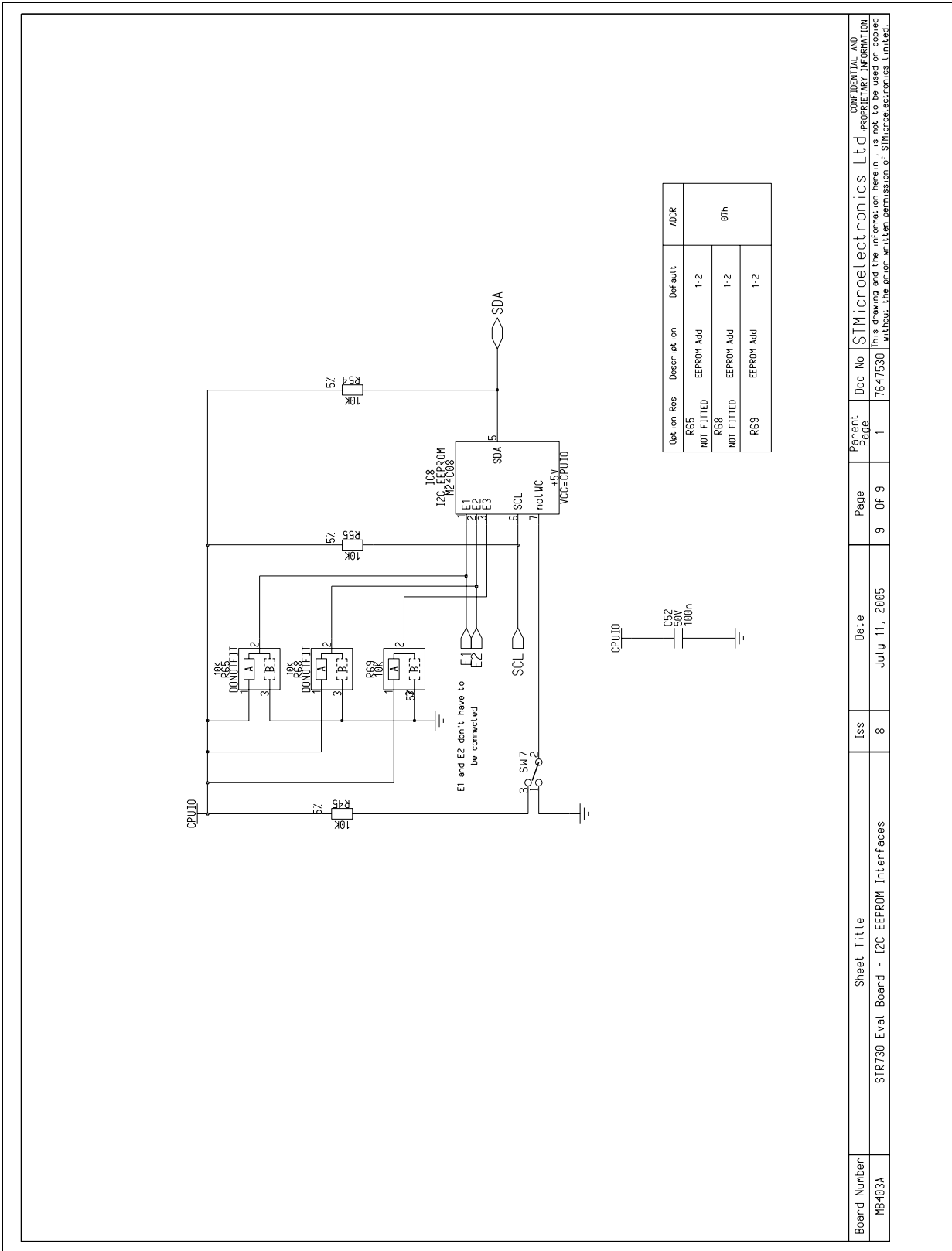

Board Number: MB403A | Sheet Title: STR730 Eval Board - I2C EEPROM Interfaces | Iss: 8 | Date: July 11, 2005 | Page: 9 of 9 | Parent Page: 1 | Doc No: 7647530 | CONFIDENTIAL AND PROPRIETARY INFORMATION. This drawing and the information herein is not to be used or copied without the prior written permission of STMicroelectronics Limited.

## 5 Revision history

Date	Revision	Changes
26-September-2005	1	Initial external release.

---

Information furnished is believed to be accurate and reliable. However, STMicroelectronics assumes no responsibility for the consequences of use of such information nor for any infringement of patents or other rights of third parties which may result from its use. No license is granted by implication or otherwise under any patent or patent rights of STMicroelectronics. Specifications mentioned in this publication are subject to change without notice. This publication supersedes and replaces all information previously supplied. STMicroelectronics products are not authorized for use as critical components in life support devices or systems without express written approval of STMicroelectronics.

The ST logo is a registered trademark of STMicroelectronics.  
All other names are the property of their respective owners

© 2005 STMicroelectronics - All rights reserved

STMicroelectronics group of companies

Australia - Belgium - Brazil - Canada - China - Czech Republic - Finland - France - Germany - Hong Kong - India - Israel - Italy - Japan -  
Malaysia - Malta - Morocco - Singapore - Spain - Sweden - Switzerland - United Kingdom - United States of America

[www.st.com](http://www.st.com)

